

Модель весов

**AD, AD-H, AP, DB, DB-II, DL, ER,
ER-J, EB, ED, HD**

Схема подключения

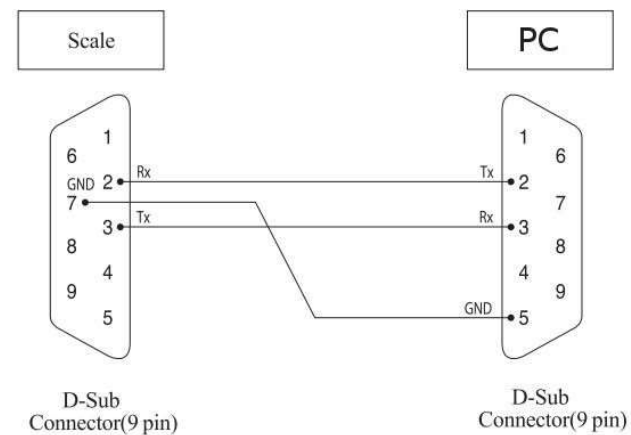

**CL-5000,CL-5000J,LP-II,BW(new),
EC, ED-H (для EC необходим
кабель FEMALE-FEMALE), HB, HE**

Serial Communication

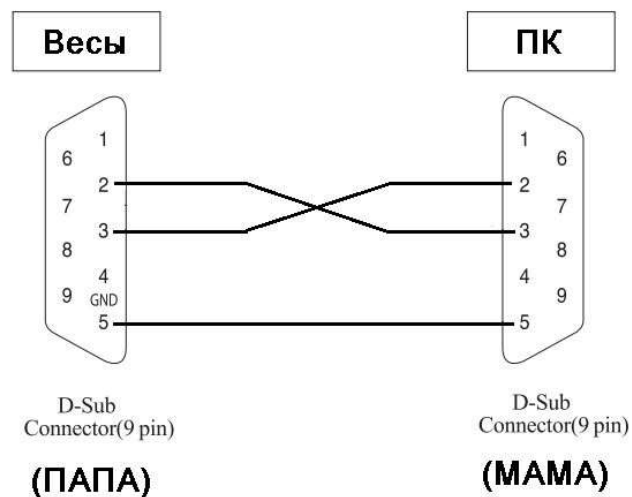

BW, SWN, PR LCD(II), TWN (для пульта TWN необходим кабель FEMALE-FEMALE)

Serial Communication

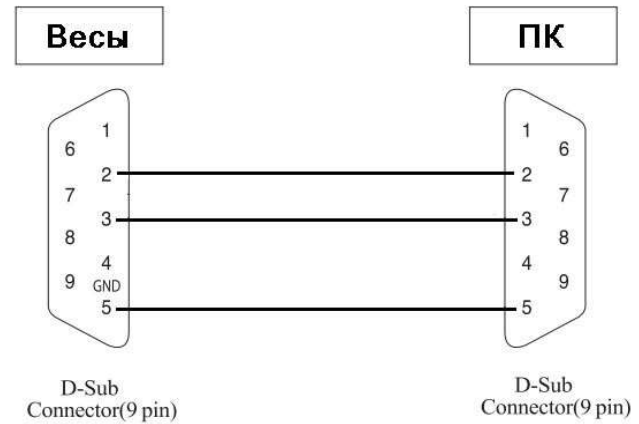

LP(ver. 1.5), LP(ver. 1.6)

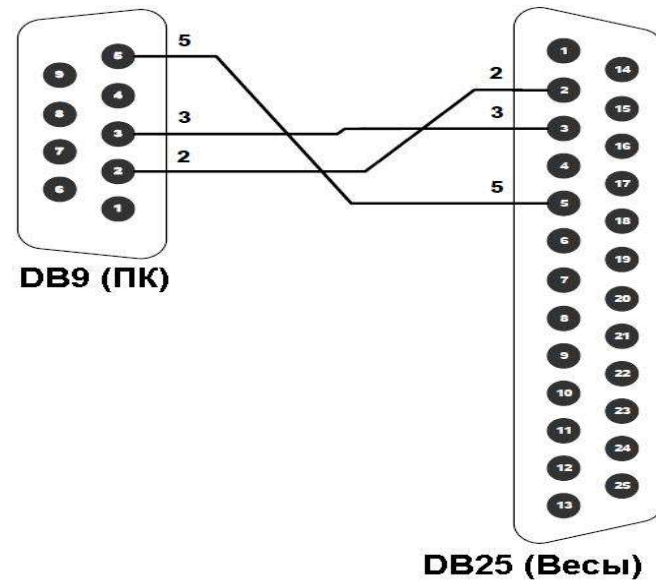

Весовые индикаторы

**CI-1560, CI-2001A, CI-5010, CI-5200,
CI-5500, CI-8000, CI-6000A, CI-6020,
CI-600A, CI-600D**

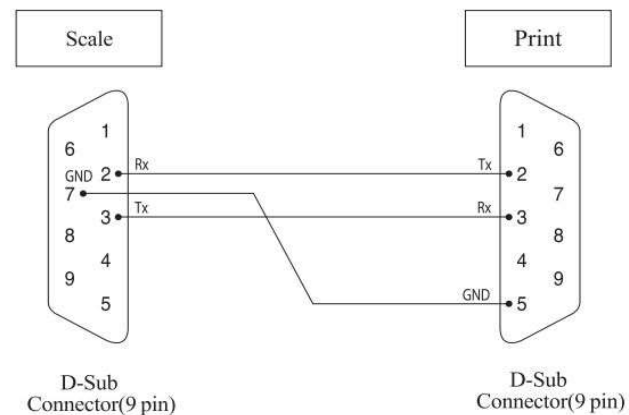

CI-6000A1

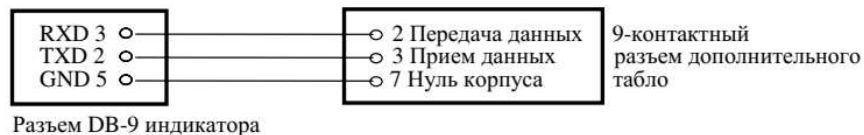
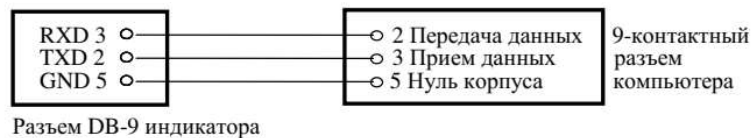

Схемы соединений по интерфейсу COM2:

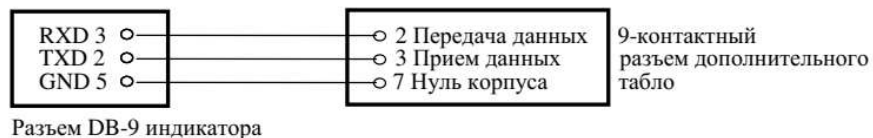
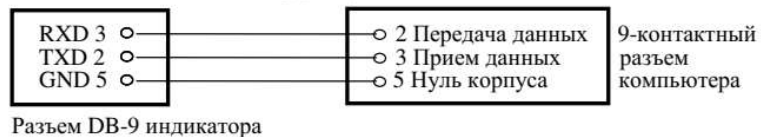

RW

